

BSK industrial fluid processing department, provide various fluid technology through commercial, industrial and processing customer services and solutions, which can improve the work efficiency and production capacity. If you have any questions or suggestions after reading the sample, please contact us at any time, email address:

Jiangmai@bskfluid.com

**BSK** Pneumatic  
Diaphragm  
Pump

**BSK**

[www.bskfluid.com](http://www.bskfluid.com)

**BSK Fluid Technology LLC**

Add: 3625 Aqua Springs Drive Plano, TX 75025 U.S.A  
Tel : (+1) 619-259-4428 Fax: (+1) 972-238-1161

SN:BSK-CN-G-201604

**BSK**   
BSK Fluid Technology LLC.

# APPLICATION AREA

- Tanker / Passenger car / Train unloading
- Large tank / Tank transport
- Wastewater treatment / Fluid filtration
- Chemical production
- Common transport / Supply
- Packing / Fill
- Batch processing / Mixed
- System flushing
- Cycle / Recovery



## MARITIME AFFAIRS

Emission and transmission

Sewage  
Seawater  
Diesel engine

## ELECTRONICS

Emission and transmission

Wastewater  
Strong acid  
Alkali

## COAL MINE

Emission

Sewage  
Mixing  
Slush

## MEDICINE

The food and drug material  
Supply and delivery

FDA material

## CHEMICAL PRODUCTION

Soap

Cleaning agent  
Clean/Polish  
Paint/Dye  
Adhesive  
Printing ink  
For shear sensitive materials

## CAR

Supply and delivery

Sealant  
Binder  
Electroplating solution  
Solvent  
Paint

# INDUSTRY



# PRODUCT PERFORMANCE CHARACTERISTICS

## SIMPLIFIED STRUCTURE

- ✦ The main valve and air motor are in the modular structure
- ✦ Easy to disassemble and maintain

## ANTI-OXIDIZING

- ✦ Anti-oxidizing, non-toxic Treatment on the modular structure
- ✦ Enhanced abrasion resistance
- ✦ Not affected by temperature variation

## NEW PATENTED MAIN VALVE

- ✦ Provided with dual polymer ceramic air system
- ✦ Stable in performance and free of dead spots
- ✦ Self-lubricating and maintenance-free

## ENERGY CONSERVATION AND NOISE REDUCTION

- ✦ Anti-icing vacuum chamber
- ✦ Effectively reduce noise during operation

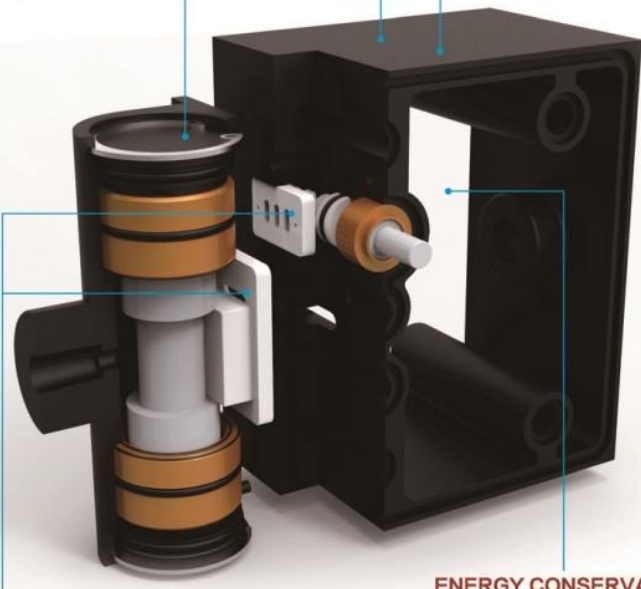

## SIMPLICITY

- It is maintenance-free due to the installation of high-strength engineering plastic components
- Use less consumable parts



## RESISTANCE TO DIRTY AIR

- The use of polymer ceramic dynamic seal makes it more wear-resisting
- It is applicable to the harsh environment of air source



## STABILITY

- The dual reversing system can assure working stability while maximizing efficiency

✦ As required in the American technology standard, its spare parts are coated with stoving varnish, being beautiful and practical, anti-corrosive and easy to clean.

✦ Its unique chamber design and stepless regulating valve can effectively prevent the damage to the pump body so as to maximize flow.

✦ The lightweight design of pump is convenient for its movement.

✦ With unique dual-seal construction, it is free of leakage problem. The first seal is the seal groove of inbuilt diaphragm inside the pump; and the secondary seal the bolt-type connection structure.

✦ With ultra-low-pressure start-up capability, it can start at air pressure of 1.5KG or less.

✦ The optimization design of system conduces to reduction of wearing parts, easy disassembly and maintenance.



Note: The ratio of the number of any pneumatic diaphragm pump parts about 20% less

WHY CHOOSE US

# PNEUMATIC DIAPHRAGM PUMP

## PVDF

- + BA25KV
- + BA40KV

## CI

- + BA50CI
- + BA80CI

## PP

- + P06PP
- + P15PP
- + BA25PP
- + BA40PP
- + BA50PP

## AL

- + BA25AL
- + BA40AL
- + BA50AL
- + BA80AL

## CS

- + P15CS
- + BA25CS
- + BA40CS
- + BA50CS
- + BA80CS

## SS

- + P15SS
- + BA25SS
- + BA40SS
- + BA50SS
- + BA80SS



**PRODUCT  
INTRO >>**

# P06PP - X X X - X

**SEAT MATERIAL**  
S-Stainless steel  
P-Polypropylene

**DIAPHRAGM MATERIAL**  
9-Santoprene  
H-Hytrel  
T-PTFE

**BALL MATERIAL**  
9-Santoprene  
H-Hytrel  
A-Acetal  
T-PTFE

**PORTING**  
A-BSP  
B-NPT(F)



## PRODUCT PARAMETERS

### TECHNICAL PARAMETERS

Air inlet	1/4-18NPTF-1
Fluid Outlet	1/4-18NPTF-1
Fluid Inlet	1/4-18NPTF-1
Max. Flow	27L/Min
Max. Head	28M (Water)
Max. Self-priming Lift (dry)	4.5m
Max. Air Pressure	5.0bar
Max. Particle Diameter	1mm
Max. installation Dimension	185*162*120mm
Weight	1.3kg
Noise	<80db

### MATERIAL TEMPERATURE LIMITS

Hytrel	-20°-150°F(-29°-66°C)
Viton	-40°-350°F(-40°-176.6°C)
Acetal	40°-150°F(4.4°-65.5°C)
Santoprene	-40°-225°F(-40°-107.2°C)
Nitrile	10°-180°F(-12°-82°C)
Teflon	40°-220°F(4.4°-104°C)
Polypropylene	32°-175°F(0°-79.4°C)

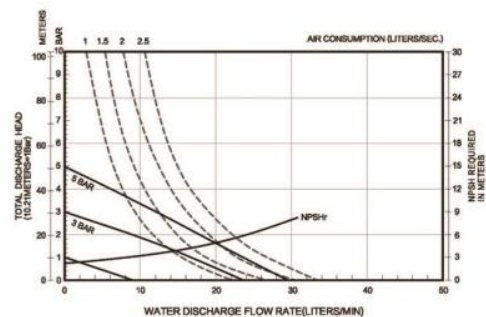

PLASTIC PUMP

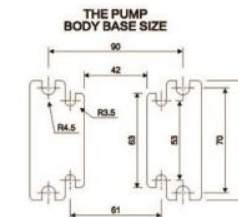
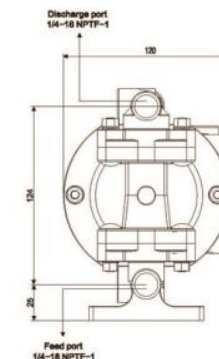
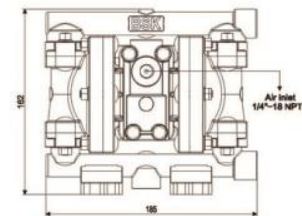



# P15PP

- X X X - X

**SEAT MATERIAL**  
P-Polypropylene  
O-Aluminum alloy  
S-Stainless steel  
9-Santoprene

**DIAPHRAGM MATERIAL**  
9-Santoprene  
H-Hytral  
V-Viton  
T-PTFE/Santoprene

**BALL MATERIAL**  
T-PTFE  
A-Acetal  
V-Viton  
H-Hytral  
9-Santoprene

**PORTING**  
A-BSP  
B-NPT(F)



## PRODUCT PARAMETERS

### TECHNICAL PARAMETERS

Air Inlet	1/4"-18NPTF-1
Fluid Outlet	1/2"-14 NPTF-1
Fluid Inlet	1/2"-14 NPTF-1
Max. Flow	49.5 L/Min
Max. Head	70M (Water)
Max. Self-priming Lift (dry)	4.5m
Max. Air Pressure	6.9bar
Max. Particle Diameter	2.5mm
Max. Installation Dimension	195*275*160mm
Weight	2.4kg
Noise	<80db

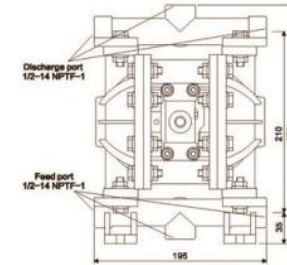

### MATERIAL TEMPERATURE LIMITS

Hytral	-20°-150°F (-29°-66°C)
Viton	-40°-350°F (-40°-176.6°C)
Acetal	40°-150°F (4.4°-65.5°C)
Santoprene	-40°-225°F (-40°-107.2°C)
Nitrile	10°-180°F (-12°-82°C)
Teflon	40°-220°F (4.4°-104°C)
Polypropylene	32°-175°F (0°-79.4°C)

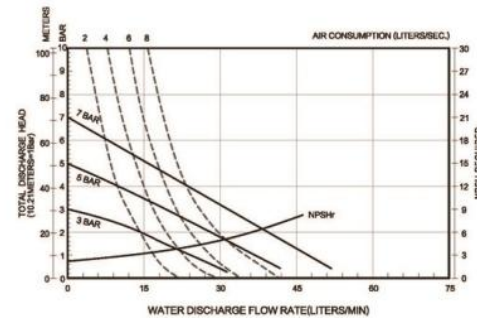
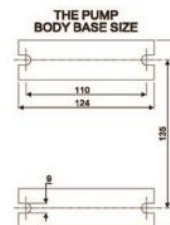
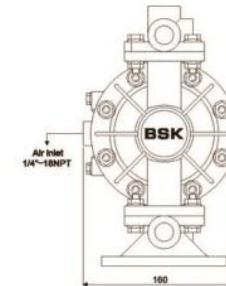

# P15CS - X X X - X

**SEAT MATERIAL**  
S-Stainless steel  
P-Polypropylene  
O-Aluminum alloy

**DIAPHRAGM MATERIAL**  
9-Santoprene  
H-Hytrel  
V-Viton  
T-PTFE/Santoprene

**BALL MATERIAL**  
9-Santoprene  
H-Hytrel  
V-Viton  
A-Acetal  
T-PTFE

**PORTING**  
A-BSP  
B-NPT(F)



## PRODUCT PARAMETERS

### TECHNICAL PARAMETERS

Air Inlet	1/4-18NPTF-1
Fluid Outlet	1/2-14 BSP
Fluid Inlet	1/2-14 BSP
Max. Flow	46L/Min
Max. Head	70M (Water)
Max. Self-priming Lift (dry)	4.5m
Max. Air Pressure	6.9bar
Max. Particle Diameter	2.5mm
Max. Installation Dimension	188*229.5*153.5mm
Weight	5.5kg
Noise	<80db

### MATERIAL TEMPERATURE LIMITS

Hytrel	-20°-150°F (-29°-66°C)
Viton	-40°-350°F (-40°-176.6°C)
Acetal	40°-150°F (4.4°-65.5°C)
Santoprene	-40°-225°F (-40°-107.2°C)
Nitrile	10°-180°F (-12°-82°C)
Teflon	40°-220°F (4.4°-104°C)
Polypropylene	32°-175°F (0°-79.4°C)

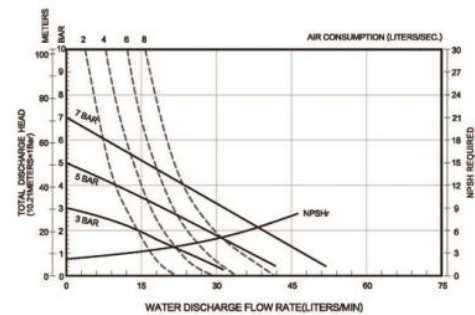

CAST STEEL PUMP

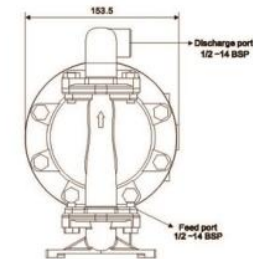
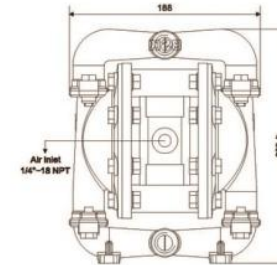

### THE PUMP BODY BASE SIZE

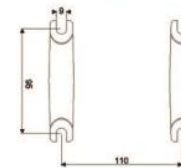

# P15SS - X X X - X

**SEAT MATERIAL**  
S-Stainless steel  
P-Polypropylene  
O-Aluminum alloy

**DIAPHRAGM MATERIAL**  
9-Santoprene  
H-Hytrel  
V-Viton  
T-PTFE/Santoprene

**BALL MATERIAL**  
9-Santoprene  
H-Hytrel  
V-Viton  
A-Acetal  
T-PTFE

**PORTING**  
A-BSP  
B-NPT(F)



## PRODUCT PARAMETERS

### TECHNICAL PARAMETERS

Air Inlet	1/4"-18NPTF-1
Fluid Outlet	1/2"-14 BSP
Fluid Inlet	1/2"-14 BSP
Max. Flow	46L/Min
Max. Head	70M (Water)
Max. Self-priming Lift (dry)	4.5m
Max. Air Pressure	6.9bar
Max. Particle Diameter	2.5mm
Max. Installation Dimension	188*229.5*153.5mm
Weight	5.5kg
Noise	<80db

### MATERIAL TEMPERATURE LIMITS

Hytrel	-20°-150°F(-29°-66°C)
Viton	-40°-350°F(-40°-176.6°C)
Acetal	40°-150°F(4.4°-65.5°C)
Santoprene	-40°-225°F(-40°-107.2°C)
Nitrile	10°-180°F(-12°-82°C)
Teflon	40°-220°F(4.4°-104°C)
Polypropylene	32°-175°F(0°-79.4°C)

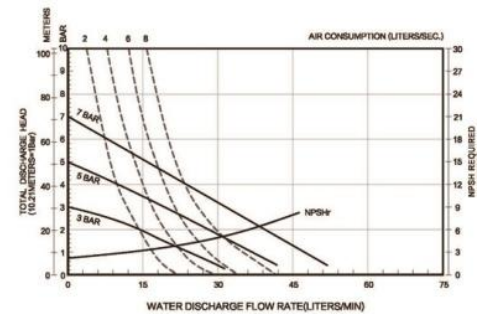

STAINLESS STEEL PUMP

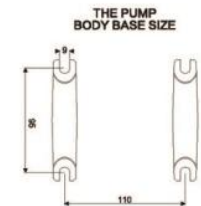
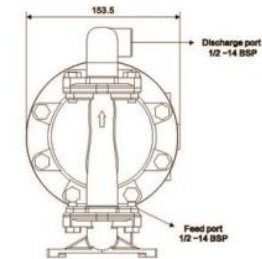
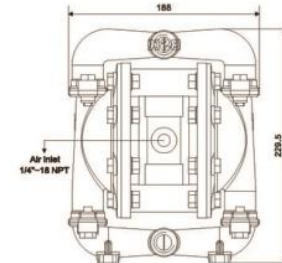



# BA25PP - X X X - X

**SEAT MATERIAL**  
P-Polypropylene  
O-Aluminum alloy  
S-Stainless steel  
9-Santoprene

**DIAPHRAGM MATERIAL**  
9-Santoprene  
H-Hytrek  
V-Viton  
T-PTFE/Santoprene  
Nitrile butadiene rubber

**BALL MATERIAL**  
T-PTFE  
A-Acetal  
Nitrile butadiene rubber  
V-Viton  
H-Hytrek  
9-Santoprene

**PORTING**  
C-Flange

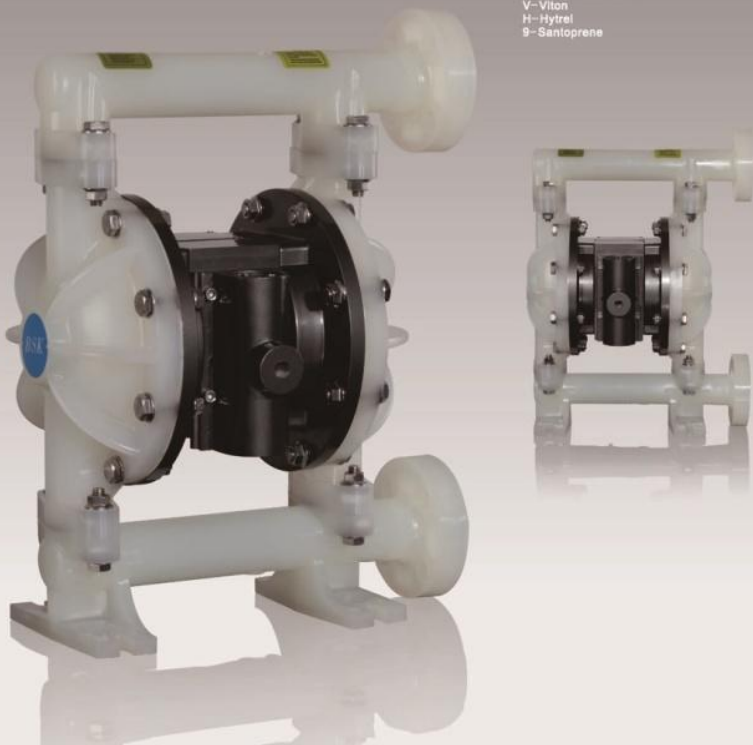

## PRODUCT PARAMETERS

### TECHNICAL PARAMETERS

Air Inlet	1/4"-18NPTF-1
Fluid Outlet	1"Side flange
Fluid Inlet	1"Side flange
Max. Flow	232L/Min
Max. Head	70M (Water)
Max. Self-priming Lift (dry)	4m
Max. Air Pressure	8.3bar
Max. Particle Diameter	3mm
Max. installation Dimension	353*477.5*233.2mm
Weight	9.5kg
Noise	<80db

### MATERIAL TEMPERATURE LIMITS

Hytrek	-20°-150°F (-29°-66°C)
Viton	-40°-350°F (-40°-176.6°C)
Acetal	40°-150°F (4.4°-65.5°C)
Santoprene	-40°-225°F (-40°-107.2°C)
Nitrile	10°-180°F (-12°-82°C)
Teflon	40°-220°F (4.4°-104°C)
Polypropylene	32°-175°F (0°-79.4°C)

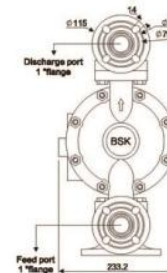
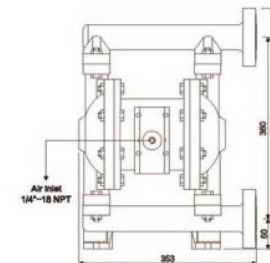

THE PUMP BODY BASE SIZE

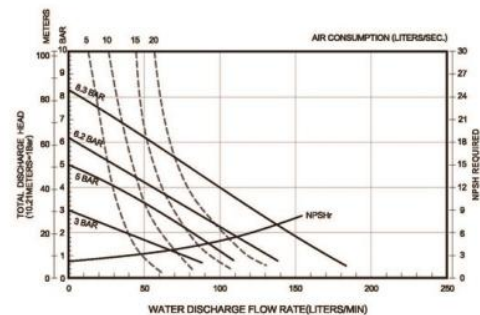
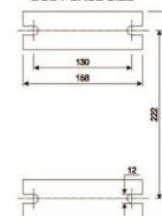

# BA25AL - X X X - X

**SEAT MATERIAL**  
S-Stainless steel  
P-Polypropylene  
O-Aluminum alloy  
9-Santoprene

**DIAPHRAGM MATERIAL**  
9-Santoprene  
H-Hytral  
V-Viton  
T-PTFE/Santoprene  
Nitrile butadiene rubber

**BALL MATERIAL**  
9-Santoprene  
H-Hytral  
V-Viton  
Nitrile butadiene rubber  
A-Acetal  
T-PTFE

**PORTING**  
A-BSP  
B-NPT(F)



ALUMINUM ALLOY PUMP

## PRODUCT PARAMETERS

### TECHNICAL PARAMETERS

Air Inlet	1/4-18NPTF-1
Fluid Outlet	1-11-1/2NPTF-1, Rp1-11BSP
Fluid Inlet	1-11-1/2NPTF-1, Rp1-11BSP
Max. Flow	202L/Min
Max. Head	70M (Water)
Max. Self-priming Lift (dry)	4m
Max. Air Pressure	8.3bar
Max. Particle Diameter	3mm
Max. Installation Dimension	249.5*360.5*245mm
Weight	9.5kg
Noise	<80db

### MATERIAL TEMPERATURE LIMITS

Hytral	-20°-150°F (-29°-66°C)
Viton	-40°-350°F (-40°-176.6°C)
Acetal	40°-150°F (4.4°-65.5°C)
Santoprene	-40°-225°F (-40°-107.2°C)
Nitrile	10°-180°F (-12°-82°C)
Teflon	40°-220°F (4.4°-104°C)
Polypropylene	32°-175°F (0°-79.4°C)

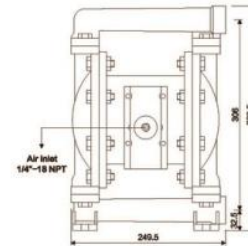

Discharge port 1-11 1/2 NPTF-1  
1-11 BSP Rp

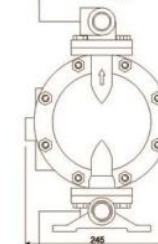

Feed port 1-11 1/2 NPTF-1  
1-11 BSP Rp

THE PUMP BODY BASE SIZE

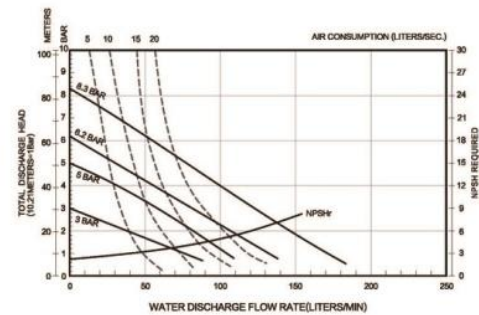

# BA25CS - X X X - X

**SEAT MATERIAL**  
S-Stainless steel  
P-Polypropylene  
O-Aluminum alloy  
9-Santoprene

**DIAPHRAGM MATERIAL**  
9-Santoprene  
H-Hytrel  
V-Viton  
T-PTFE/Santoprene  
Nitrile butadiene rubber

**BALL MATERIAL**  
9-Santoprene  
H-Hytrel  
V-Viton  
Nitrile butadiene rubber  
A-Acetal  
T-PTFE

**PORTING**  
A-BSP  
B-NPT(F)



## PRODUCT PARAMETERS

### TECHNICAL PARAMETERS

Air Inlet	1/4-18NPTF-1
Fluid Outlet	1-11-1/2NPTF-1,Rp1-11BSP
Fluid Inlet	1-11-1/2NPTF-1,Rp1-11BSP
Max. Flow	202L/Min
Max. Head	70M (Water)
Max. Self-priming Lift (dry)	4m
Max. Air Pressure	8.3bar
Max. Particle Diameter	3mm
Max. Installation Dimension	244*360.5*245mm
Weight	14.5kg
Noise	<80db

### MATERIAL TEMPERATURE LIMITS

Hytrel	-20°-150°F (-29°-66°C)
Viton	-40°-350°F (-40°-176.6°C)
Acetal	40°-150°F (4.4°-65.5°C)
Santoprene	-40°-225°F (-40°-107.2°C)
Nitrile	10°-180°F (-12°-82°C)
Teflon	40°-220°F (4.4°-104°C)
Polypropylene	32°-175°F (0°-79.4°C)

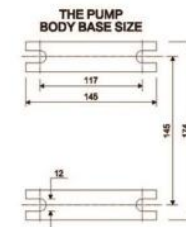
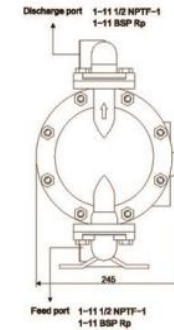
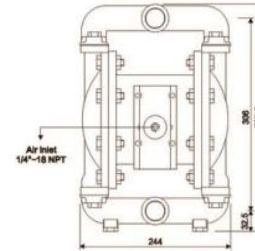
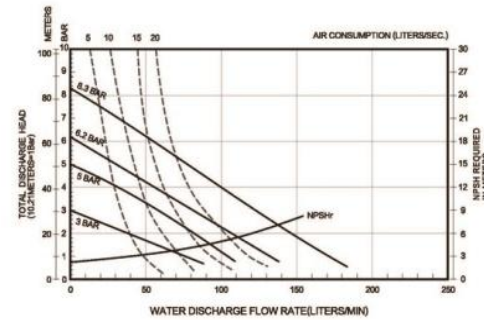

# BA25SS - X X X - X

**SEAT MATERIAL**  
S-Stainless steel  
P-Polypropylene  
O-Aluminum alloy

**DIAPHRAGM MATERIAL**  
9-Santoprene  
H-Hytrel  
V-Viton  
T-PTFE/Santoprene  
Nitrile butadiene rubber

**BALL MATERIAL**  
9-Santoprene  
H-Hytrel  
V-Viton  
Nitrile butadiene rubber  
A-Acetal  
T-PTFE

**PORTING**  
A-BSP  
B-NPT(F)



STAINLESS STEEL PUMP

## PRODUCT PARAMETERS

### TECHNICAL PARAMETERS

Air Inlet	1/4-18NPTF-1
Fluid Outlet	1-11-1/2NPTF-1, Rp1-11BSP
Fluid Inlet	1-11-1/2NPTF-1, Rp1-11BSP
Max. Flow	202L/Min
Max. Head	70M (Water)
Max. Self-priming Lift (dry)	4m
Max. Air Pressure	8.3bar
Max. Particle Diameter	3mm
Max. Installation Dimension	244*360.5*245mm
Weight	14.5kg
Noise	<80db

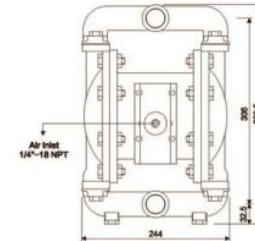

### MATERIAL TEMPERATURE LIMITS

Hytrel	-20°-150°F (-29°-66°C)
Viton	-40°-350°F (-40°-176.6°C)
Acetal	40°-150°F (4.4°-65.5°C)
Santoprene	-40°-225°F (-40°-107.2°C)
Nitrile	10°-180°F (-12°-82°C)
Teflon	40°-220°F (4.4°-104°C)
Polypropylene	32°-175°F (0°-79.4°C)

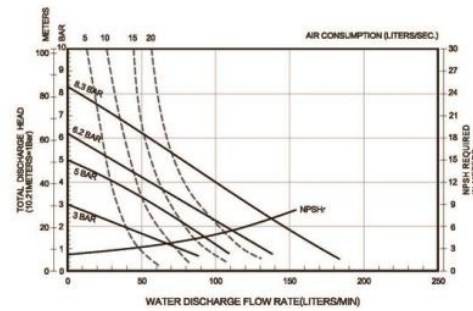
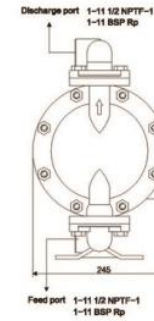

### THE PUMP BODY BASE SIZE

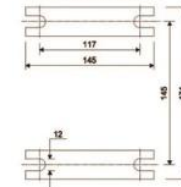



# BA40PP - X X X - X

**SEAT MATERIAL**  
P-Polypropylene  
O-Aluminum alloy  
S-Stainless steel  
9-Santoprene

**DIAPHRAGM MATERIAL**  
9-Santoprene  
H-Hytral  
V-Viton  
T-PTFE/Santoprene  
Nitrile butadiene rubber

**BALL MATERIAL**  
9-Santoprene  
H-Hytral  
V-Viton  
Nitrile butadiene rubber  
A-Acetal  
T-PTFE

**PORTING**  
C-Flange

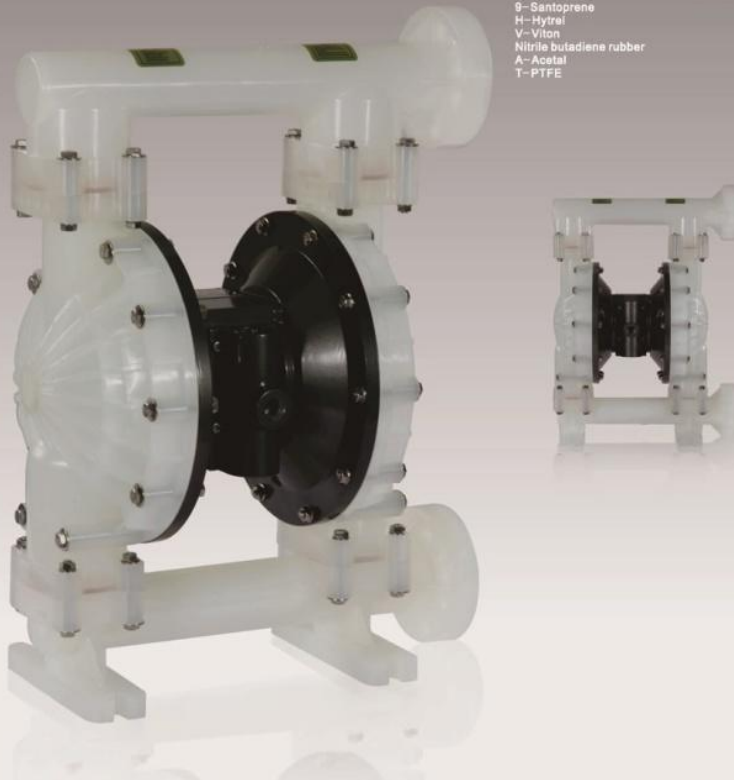

## PRODUCT PARAMETERS

### TECHNICAL PARAMETERS

Air Inlet	1/2"-14NPTF-1
Fluid Outlet	1.5"Side flange
Fluid Inlet	1.5"Side flange
Max. Flow	456L/Min
Max. Head	70M (Water)
Max. Self-priming Lift (dry)	4.5m
Max. Air Pressure	8.3bar
Max. Particle Diameter	6mm
Max. Installation Dimension	635*449*304mm
Weight	19kg
Noise	<80db

### MATERIAL TEMPERATURE LIMITS

Hytral	-20°-150°F(-29°-66°C)
Viton	-40°-350°F(-40°-176.6°C)
Acetal	40°-150°F(4.4°-65.5°C)
Santoprene	-40°-225°F(-40°-107.2°C)
Nitrile	10°-180°F(-12°-82°C)
Teflon	40°-220°F(4.4°-104°C)
Polypropylene	32°-175°F(0°-79.4°C)

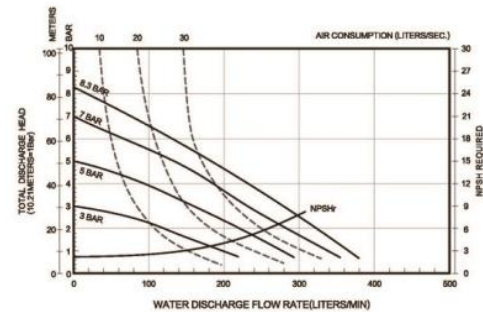

PLASTIC PUMP

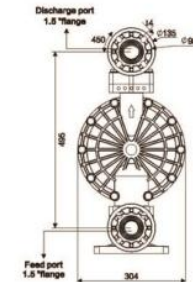
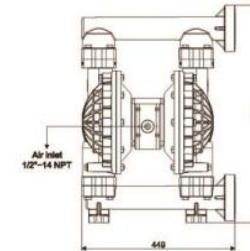

### THE PUMP BODY BASE SIZE

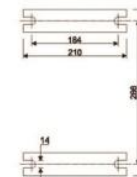

# BA40AL - X X X - X

**SEAT MATERIAL**  
P-Polypropylene  
O-Aluminum alloy  
S-Stainless steel  
9-Santoprene

**DIAPHRAGM MATERIAL**  
9-Santoprene  
H-Hytrel  
V-Viton  
T-PTFE/Santoprene  
Nitrile butadiene rubber

**BALL MATERIAL**  
9-Santoprene  
H-Hytrel  
V-Viton  
Nitrile butadiene rubber  
A-Acetal  
T-PTFE

**PORTING**  
A-BSP  
B-NPT(F)

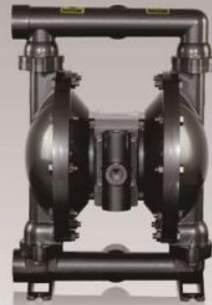

ALUMINUM ALLOY PUMP

## PRODUCT PARAMETERS

### TECHNICAL PARAMETERS

Air Inlet	1/2-14NPTF-1
Fluid Outlet	1-1/2"-11-1/2NPTF-1, 1-1/2-11BSP
Fluid Inlet	1-1/2"-11-1/2NPTF-1, 1-1/2-11BSP
Max. Flow	396L/Min
Max. Head	70M (Water)
Max. Self-priming Lift (dry)	4.5m
Max. Air Pressure	8.3bar
Max. Particle Diameter	6mm
Max. installation Dimension	351.5*498*301mm
Weight	18kg
Noise	< 80db

### MATERIAL TEMPERATURE LIMITS

Hytrel	-20°-150°F (-29°-66°C)
Viton	-40°-350°F (-40°-176.6°C)
Acetal	40°-150°F (4.4°-65.5°C)
Santoprene	-40°-225°F (-40°-107.2°C)
Nitrile	10°-180°F (-12°-82°C)
Teflon	40°-220°F (4.4°-104°C)
Polypropylene	32°-175°F (0°-79.4°C)

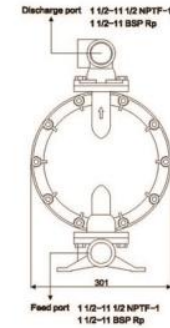
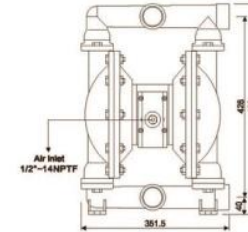

### THE PUMP BODY BASE SIZE

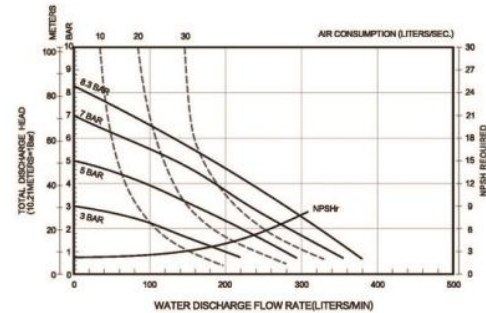
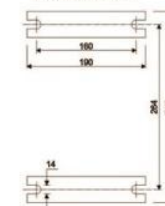

# BA40CS - X X X - X

**SEAT MATERIAL**  
P-Polypropylene  
O-Aluminum alloy  
S-Stainless steel  
9-Santoprene

**DIAPHRAGM MATERIAL**  
9-Santoprene  
H-Hytral  
V-Viton  
T-PTFE/Santoprene  
Nitrile butadiene rubber

**BALL MATERIAL**  
9-Santoprene  
H-Hytral  
V-Viton  
Nitrile butadiene rubber  
A-Acetal  
T-PTFE

**PORTING**  
A-BSP  
B-NPT(F)



CAST STEEL PUMP

## PRODUCT PARAMETERS

### TECHNICAL PARAMETERS

Air Inlet	1/2-14NPTF-1
Fluid Outlet	1-1/2"-11-1/2NPTF-1, 1-1/2-11BSP
Fluid Inlet	1-1/2"-11-1/2NPTF-1, 1-1/2-11BSP
Max. Flow	396L/Min
Max. Head	70M (Water)
Max. Self-priming Lift (dry)	4.5m
Max. Air Pressure	8.3bar
Max. Particle Diameter	6mm
Max. Installation Dimension	343*498*301mm
Weight	30kg
Noise	< 80db

### MATERIAL TEMPERATURE LIMITS

Hytral	-20°-150°F (-29°-66°C)
Viton	-40°-350°F (-40°-176.6°C)
Acetal	40°-150°F (4.4°-65.5°C)
Santoprene	-40°-225°F (-40°-107.2°C)
Nitrile	10°-180°F (-12°-82°C)
Teflon	40°-220°F (4.4°-104°C)
Polypropylene	32°-175°F (0°-79.4°C)

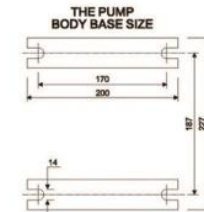
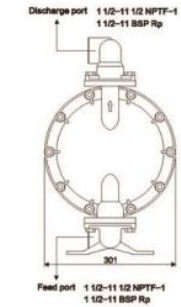
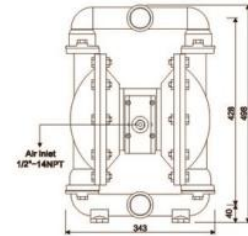
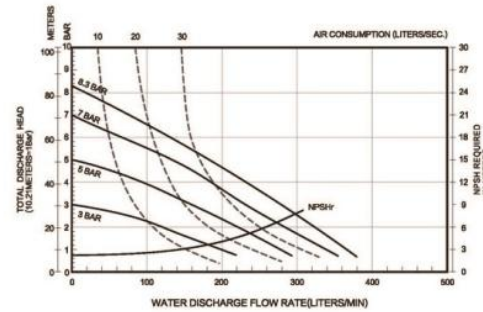

# BA40SS - X X X - X

**SEAT MATERIAL**  
P-Polypropylene  
O-Aluminum alloy  
S-Stainless steel

**DIAPHRAGM MATERIAL**  
9-Santoprene  
H-Hytrel  
V-Viton  
T-PTFE/Santoprene  
Nitrile butadiene rubber

**BALL MATERIAL**  
T-PTFE  
A-Acetal  
Nitrile butadiene rubber  
V-Viton  
H-Hytrel  
9-Santoprene

**PORTING**  
A-BSP  
B-NPT(F)



STAINLESS STEEL PUMP

## PRODUCT PARAMETERS

### TECHNICAL PARAMETERS

Air Inlet	1/2"-14NPTF-1
Fluid Outlet	1-1/2"-11-1/2NPTF-1, 1-1/2-11BSP
Fluid Inlet	1-1/2"-11-1/2NPTF-1, 1-1/2-11BSP
Max. Flow	396L/Min
Max. Head	70M (Water)
Max. Self-priming Lift (dry)	4.5m
Max. Air Pressure	8.3bar
Max. Particle Diameter	6mm
Max. installation Dimension	343*498*301mm
Weight	30kg
Noise	<80db

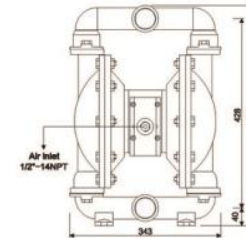

### MATERIAL TEMPERATURE LIMITS

Hytrel	-20°-150°F(-29°-66°C)
Viton	-40°-350°F(-40°-176.6°C)
Acetal	40°-150°F(4.4°-65.5°C)
Santoprene	-40°-225°F(-40°-107.2°C)
Nitrile	10°-180°F(-12°-82°C)
Teflon	40°-220°F(4.4°-104°C)
Polypropylene	32°-175°F(0°-79.4°C)

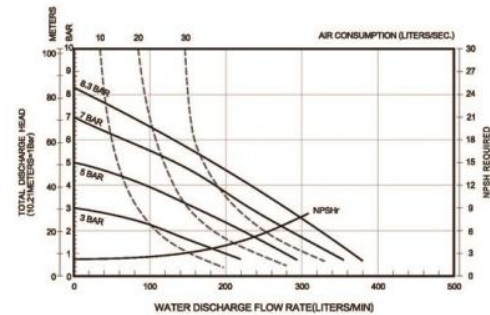
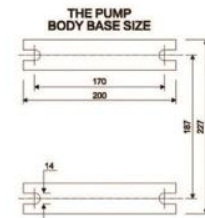
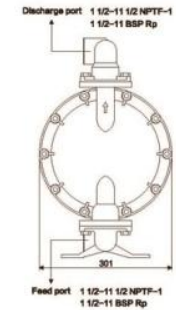



# BA50AL - X X X - X

**SEAT MATERIAL**  
P-Polypropylene  
O-Aluminum alloy  
S-Stainless steel  
9-Santoprene

**DIAPHRAGM MATERIAL**  
9-Santoprene  
H-Hytreil  
V-Viton  
T-PTFE/Santoprene  
Nitrile butadiene rubber

**BALL MATERIAL**  
T-PTFE  
A-Acetal  
Nitrile butadiene rubber  
V-Viton  
H-Hytreil  
9-Santoprene

**PORTING**  
A-BSP  
B-NPT(F)



## PRODUCT PARAMETERS

### TECHNICAL PARAMETERS

Air Inlet	3/4-14NPTF-1
Fluid Outlet	2-11-1/2NPTF-1, Rp2-11BSP
Fluid Inlet	2-11-1/2NPTF-1, Rp2-11BSP
Max. Flow	667L/Min
Max. Head	70M (Water)
Max. Self-priming Lift (dry)	4.5m
Max. Air Pressure	8.3bar
Max. Particle Diameter	7mm
Max. Installation Dimension	414*544*332mm
Weight	23kg
Noise	<80db

### MATERIAL TEMPERATURE LIMITS

Hytreil	-20°-150°F(-29°-66°C)
Viton	-40°-350°F(-40°-176.6°C)
Acetal	40°-150°F(4.4°-65.5°C)
Santoprene	-40°-225°F(-40°-107.2°C)
Nitrile	10°-180°F(-12°-82°C)
Teflon	40°-220°F(4.4°-104°C)
Polypropylene	32°-175°F(0°-79.4°C)

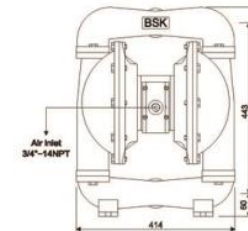
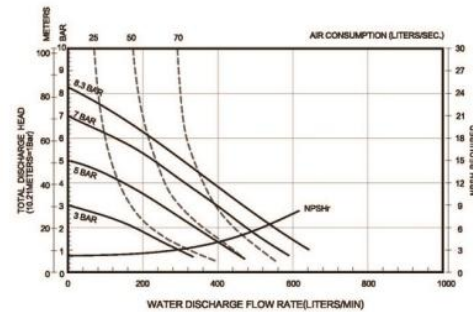

Discharge port 2-11 1/2 NPTF-1  
Rp2-11 BSP

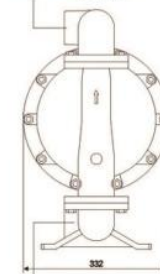

Feed port 2-11 1/2 NPTF-1  
Rp2-11 BSP

THE PUMP BODY BASE SIZE

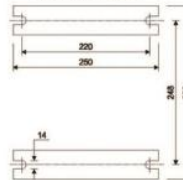

# BA50CS - X X X - X

**SEAT MATERIAL**  
P- Polypropylene  
O- Aluminum alloy  
S- Stainless steel  
9- Santoprene

**DIAPHRAGM MATERIAL**  
9- Santoprene  
H- Hytrel  
V- Viton  
T- PTFE/Santoprene  
Nitrile butadiene rubber

**BALL MATERIAL**  
T- PTFE  
A- Acetal  
Nitrile butadiene rubber  
V- Viton  
H- Hytrel  
9- Santoprene

**PORTING**  
C- Flange



CAST STEEL PUMP  
CAST IRON PUMP

## PRODUCT PARAMETERS

### TECHNICAL PARAMETERS

Air Inlet	3/4-14NPTF-1
Fluid Outlet	2" Flange
Fluid Inlet	2" Flange
Max. Flow	667L/Min
Max. Head	70M (Water)
Max. Self-priming Lift (dry)	4.5m
Max. Air Pressure	8.3bar
Max. Particle Diameter	7mm
Max. Installation Dimension	415*332*595mm
Weight	51.5kg
Noise	<80db

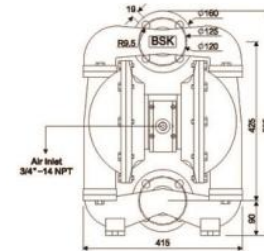

### MATERIAL TEMPERATURE LIMITS

Hytrel	-20°-150°F (-29°-66°C)
Viton	-40°-350°F (-40°-176.6°C)
Acetal	40°-150°F (4.4°-65.5°C)
Santoprene	-40°-225°F (-40°-107.2°C)
Nitrile	10°-180°F (-12°-82°C)
Teflon	40°-220°F (4.4°-104°C)
Polypropylene	32°-175°F (0°-79.4°C)

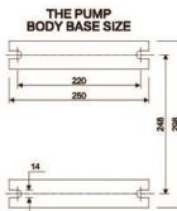
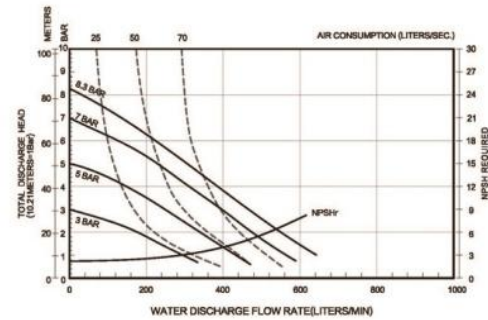
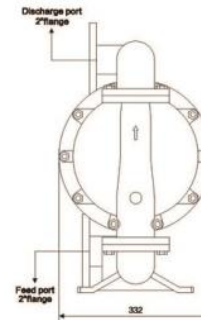

# BA50SS - X X X - X

**SEAT MATERIAL**  
P-Polypropylene  
O-Aluminum alloy  
S-Stainless steel

**DIAPHRAGM MATERIAL**  
9-Santoprene  
H-Hytreil  
V-Viton  
T-PTFE/Santoprene  
Nitrile butadiene rubber

**BALL MATERIAL**  
T-PTFE  
A-Acetal  
Nitrile butadiene rubber  
V-Viton  
H-Hytreil  
9-Santoprene

**PORTING**  
C-Flange



## PRODUCT PARAMETERS

### TECHNICAL PARAMETERS

Air Inlet	3/4-14NPTF-1
Fluid Outlet	2"Flange
Fluid Inlet	2"Flange
Max. Flow	667L/Min
Max. Head	70M (Water)
Max. Self-priming Lift (dry)	4.5m
Max. Air Pressure	8.3bar
Max. Particle Diameter	7mm
Max. Installation Dimension	415*332*595mm
Weight	51.5kg
Noise	<80db

### MATERIAL TEMPERATURE LIMITS

Hytreil	-20°-150°F(-29°-66°C)
Viton	-40°-350°F(-40°-176.6°C)
Acetal	40°-150°F(4.4°-65.5°C)
Santoprene	-40°-225°F(-40°-107.2°C)
Nitrile	10°-180°F(-12°-82°C)
Teflon	40°-220°F(4.4°-104°C)
Polypropylene	32°-175°F(0°-79.4°C)

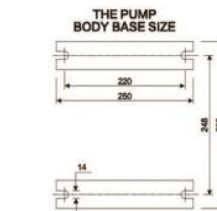
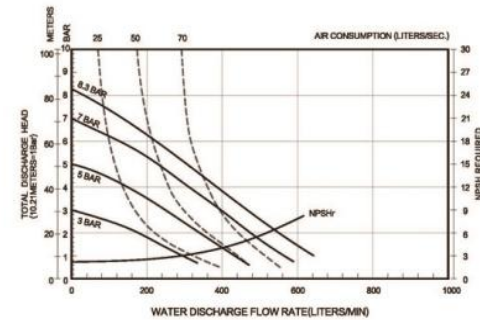
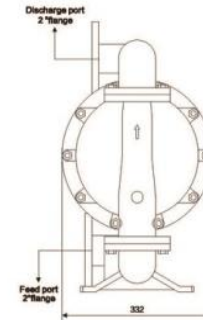
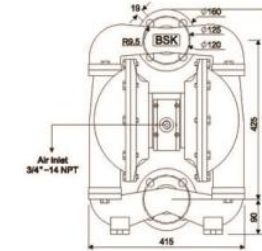

# BA80AL - X X X - X

**SEAT MATERIAL**  
P-Polypropylene  
O-Aluminum alloy  
S-Stainless steel  
9-Santoprene

**DIAPHRAGM MATERIAL**  
9-Santoprene  
H-Hytrel  
T-PTFE/Santoprene  
Nitrile butadiene rubber

**BALL MATERIAL**  
9-Santoprene  
H-Hytrel  
Nitrile butadiene rubber  
A-Acetal  
T-PTFE

**PORTING**  
A-BSP  
B-NPT(F)



ALUMINUM ALLOY PUMP

## PRODUCT PARAMETERS

### TECHNICAL PARAMETERS

Air Inlet	3/4-14NPTF-1
Fluid Outlet	3-8NPTF-1,3-11BSP
Fluid Inlet	3-8NPTF-1,3-11BSP
Max. Flow	1071L/Min
Max. Head	70M (Water)
Max. Self-priming Lift (dry)	4.5m
Max. Air Pressure	8.3bar
Max. Particle Diameter	9mm
Max. Installation Dimension	542*680*403mm
Weight	42kg
Noise	<85db

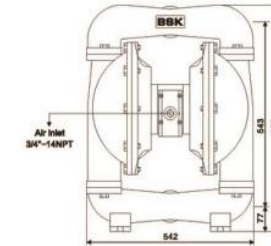

### MATERIAL TEMPERATURE LIMITS

Hytrel	-20°-150°F(-29°-66°C)
Viton	-40°-350°F(-40°-176.6°C)
Acetal	40°-150°F(4.4°-65.5°C)
Santoprene	-40°-225°F(-40°-107.2°C)
Nitrile	10°-180°F(-12°-82°C)
Teflon	40°-220°F(4.4°-104°C)
Polypropylene	32°-175°F(0°-79.4°C)

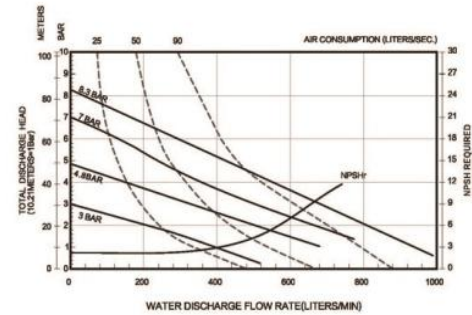
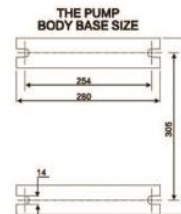
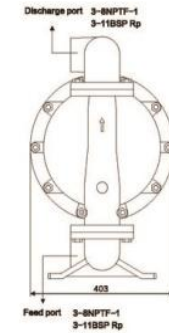



# BA80CS/CI - X X X - X

**SEAT MATERIAL**  
S-Stainless steel  
P-Polypropylene  
O-Aluminum alloy  
9-Santoprene

**DIAPHRAGM MATERIAL**  
9-Santoprene  
H-Hytrel  
V-Viton  
T-PTFE/Santoprene  
Nitrile butadiene rubber

**BALL MATERIAL**  
9-Santoprene  
H-Hytrel  
V-Viton  
Nitrile butadiene rubber  
A-Acetal  
T-PTFE

**PORTING**  
C-Flange



CAST STEEL PUMP  
CAST IRON PUMP

## PRODUCT PARAMETERS

### TECHNICAL PARAMETERS

Air Inlet	3/4-14NPTF-1
Fluid Outlet	3"Flange
Fluid Inlet	3"Flange
Max. Flow	1071L/Min
Max. Head	70M (Water)
Max. Self-priming Lift (dry)	4.5m
Max. Air Pressure	8.3bar
Max. Particle Diameter	9mm
Max. Installation Dimension	542*724*403mm
Weight	91kg
Noise	<85db

### MATERIAL TEMPERATURE LIMITS

Hytrel	-20°-150°F(-29°-66°C)
Viton	-40°-350°F(-40°-176.6°C)
Acetal	40°-150°F(4.4°-65.5°C)
Santoprene	-40°-225°F(-40°-107.2°C)
Nitrile	10°-180°F(-12°-82°C)
Teflon	40°-220°F(4.4°-104°C)
Polypropylene	32°-175°F(0°-79.4°C)

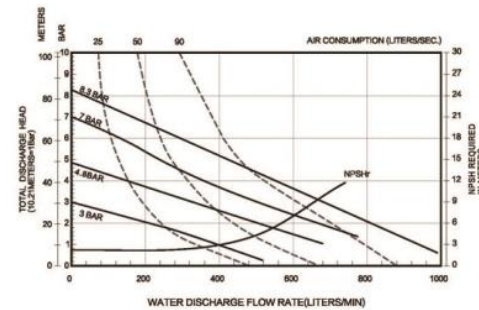
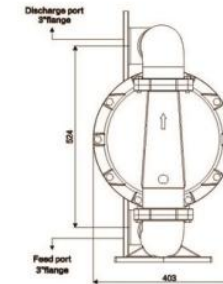
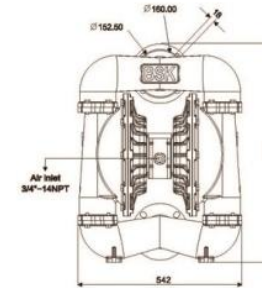

### THE PUMP BODY BASE SIZE

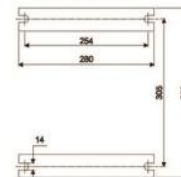

# BA80SS - X X X - X

**SEAT MATERIAL**  
S-Stainless steel  
P-Polypropylene  
O-Aluminum alloy

**DIAPHRAGM MATERIAL**  
9-Santoprene  
H-Hytrel  
V-Viton  
T-PTFE/Santoprene  
Nitrile butadiene rubber

**BALL MATERIAL**  
9-Santoprene  
H-Hytrel  
V-Viton  
Nitrile butadiene rubber  
A-Acetal  
T-PTFE

**PORTING**  
C-Flange



STAINLESS STEEL PUMP

## PRODUCT PARAMETERS

### TECHNICAL PARAMETERS

Air Inlet	3/4-14NPTF-1
Fluid Outlet	3"Flange
Fluid Inlet	3"Flange
Max. Flow	1071L/Min
Max. Head	70M (Water)
Max. Self-priming Lift (dry)	4.5m
Max. Air Pressure	8.3bar
Max. Particle Diameter	9mm
Max. Installation Dimension	542*724*403mm
Weight	95kg
Noise	<85db

### MATERIAL TEMPERATURE LIMITS

Hytrel	-20°-150°F (-29°-66°C)
Viton	-40°-350°F (-40°-176.6°C)
Acetal	40°-150°F (4.4°-65.5°C)
Santoprene	-40°-225°F (-40°-107.2°C)
Nitrile	10°-180°F (-12°-82°C)
Teflon	40°-220°F (4.4°-104°C)
Polypropylene	32°-175°F (0°-79.4°C)

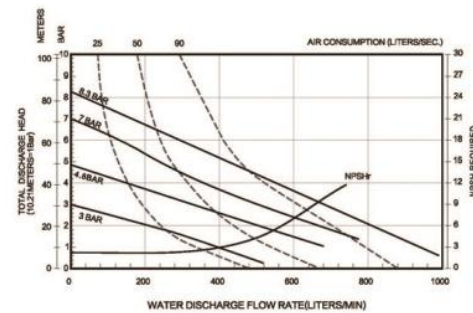
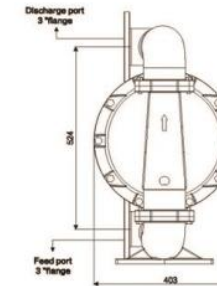
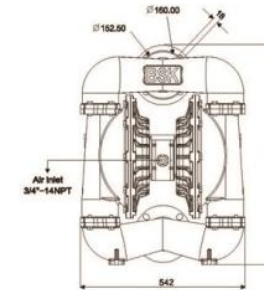

### THE PUMP BODY BASE SIZE

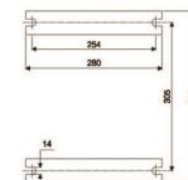



### Halogenated solvents warning

Under certain conditions, halogenated solvents can be corrosion of aluminum or galvanized parts. If a liquid contact part or pressurized fluid system containing aluminum or galvanized parts, this corrosion can lead to an explosion. Although this kind of solvent manufacturers generally added inhibitor, but there are no known inhibitors can prevent the occurrence of corrosion reaction in all conditions. Treatment and recovery or used solvents, especially need to be careful, because inhibitors usually have degradation. This kind of material can only use stainless steel or polyvinylidene fluoride (PVDF) pump. Typical halogenated hydrocarbon solvents (H.H.C.) including but not limited to: chloroform, trichloroethylene, dichloromethane, methyl chloride, carbon tetrachloride, chloroform, two vinyl chloride.

### Elastomer Selection Guide

The following liquid breakdown usually cannot be used in conjunction with neoprene or nitrile rubber, may need to Santoprene®, Viton®, Nordel and / or ptf.

<p>A. Ketones and aldehydes</p> <ol style="list-style-type: none"> <li>1. Methyl ethyl ketone</li> <li>2. Methyl acetone</li> <li>3. Acetone</li> <li>4. Formaldehyde</li> </ol> <p>Santoprene® Nordel/Teflon</p>	<p>B. Acetate</p> <ol style="list-style-type: none"> <li>1. Ethyl acetate</li> <li>2. Isopropyl acetate</li> <li>3. Amyl acetate</li> <li>4. Butyl acetate</li> </ol> <p>Santoprene® Nordel/Teflon</p>
<p>C. Aromatic hydrocarbon</p> <ol style="list-style-type: none"> <li>1. Benzene</li> <li>2. Toluene</li> <li>3. Xylene</li> <li>4. Crude benzene</li> <li>5. Hexane</li> <li>6. Cyclohexane</li> <li>7. Naphthalene</li> </ol> <p>Viton®Teflon</p>	<p>D. Chlorinated hydrocarbon</p> <ol style="list-style-type: none"> <li>1. Carbon tetrachloride</li> <li>2. Trichloroethylene</li> <li>3. Two vinyl chloride</li> <li>4. Methane chloride</li> <li>5. Alkyl chloride</li> <li>6. Chloroform</li> <li>7. Two vinyl chloride</li> </ol> <p>Viton®Teflon</p>

**BSK**  
[www.bskfluid.com](http://www.bskfluid.com)

